

BABY CHANGING STATIONS

Recessed kit for BabyMedi horizontal baby changing stations

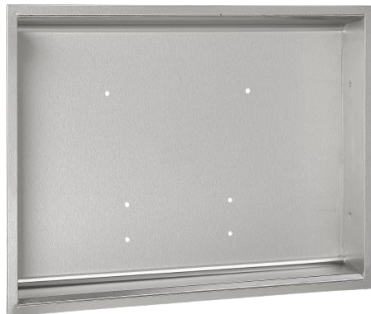

KT0016HCS
Satin finish



KT0016HCSB
Matte black finish

General description

- Kit to recess the BabyMedi horizontal baby changing station to the wall.
- This kit to recess the BabyMedi horizontal baby changing station allows the changing table to be completely flush with the wall once it is closed, not taking up unnecessary space and thus allowing the creation of more open spaces free of obstacles.
- Possibility of combining finishes between the kit for recess and the baby changing station.
- Maximum robustness and vandal-proof design.
- Excellent integration and aesthetic level.

Components and materials

- **KT0016HCS:** kit for recessing into the wall the BabyMedi horizontal baby changing stations CP0016HCS or CP0016HCSB by Mediclinics. Made of AISI 304 stainless steel with a satin finish.
- **KT0016HCSB:** kit for recessing into the wall the BabyMedi horizontal baby changing stations CP0016HCS or CP0016HCSB by Mediclinics. Made of AISI 304 stainless steel with a matte black finish.
- **WALL BOX:** 0.8 mm thick, made of AISI 304 stainless steel with satin finish (KT0016HCS) or matt black finish (KT0016HCSB), with 4 Ø 6.5 mm side holes to fix the changing table to the hole in the wall.
- **FRAME:** integrated into the same wall box, 0.8mm thick, made of AISI 304 stainless steel with a satin finish (KT0016HCS) or a matte black finish (KT0016HCSB).
- **SCREWS:** for wall mounting are not included. It is recommended the use of stainless steel screws and specific for the type of wall where the installation will be made.

Technical specifications

Dimensions	961 x 710 x 102 mm
Wall hole dimensions	880 x 648 x 99 mm
Wall box thickness	0,8 mm
Frame thickness	0,8 mm
Net weight	6,3 Kg

Dimensions

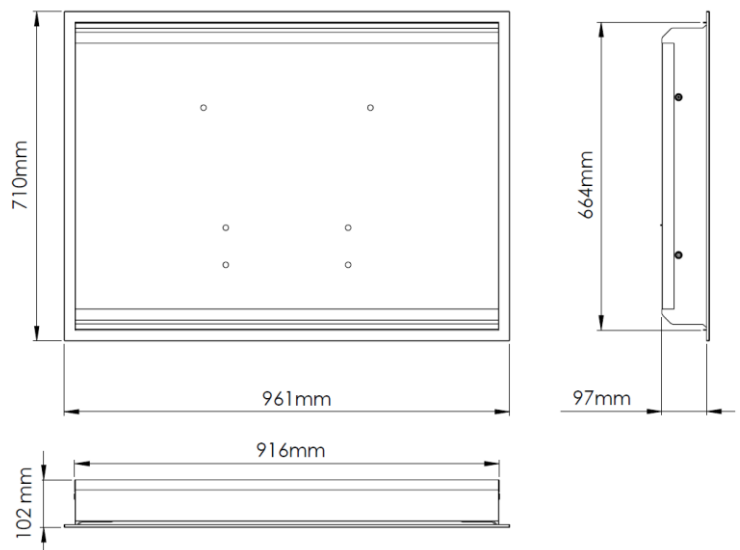

Dimensions: ± 4%

Mounting

Recommended height distance from the floor

Fix the kit with the most suitable screws for the type of wall, through the holes on the side of the mounting chassis, to the wall, at the points indicated with an "S" in the following figure and always following, step by step, the mounting instructions you will find in the "Installation and Assembly Manual" provided with the unit.

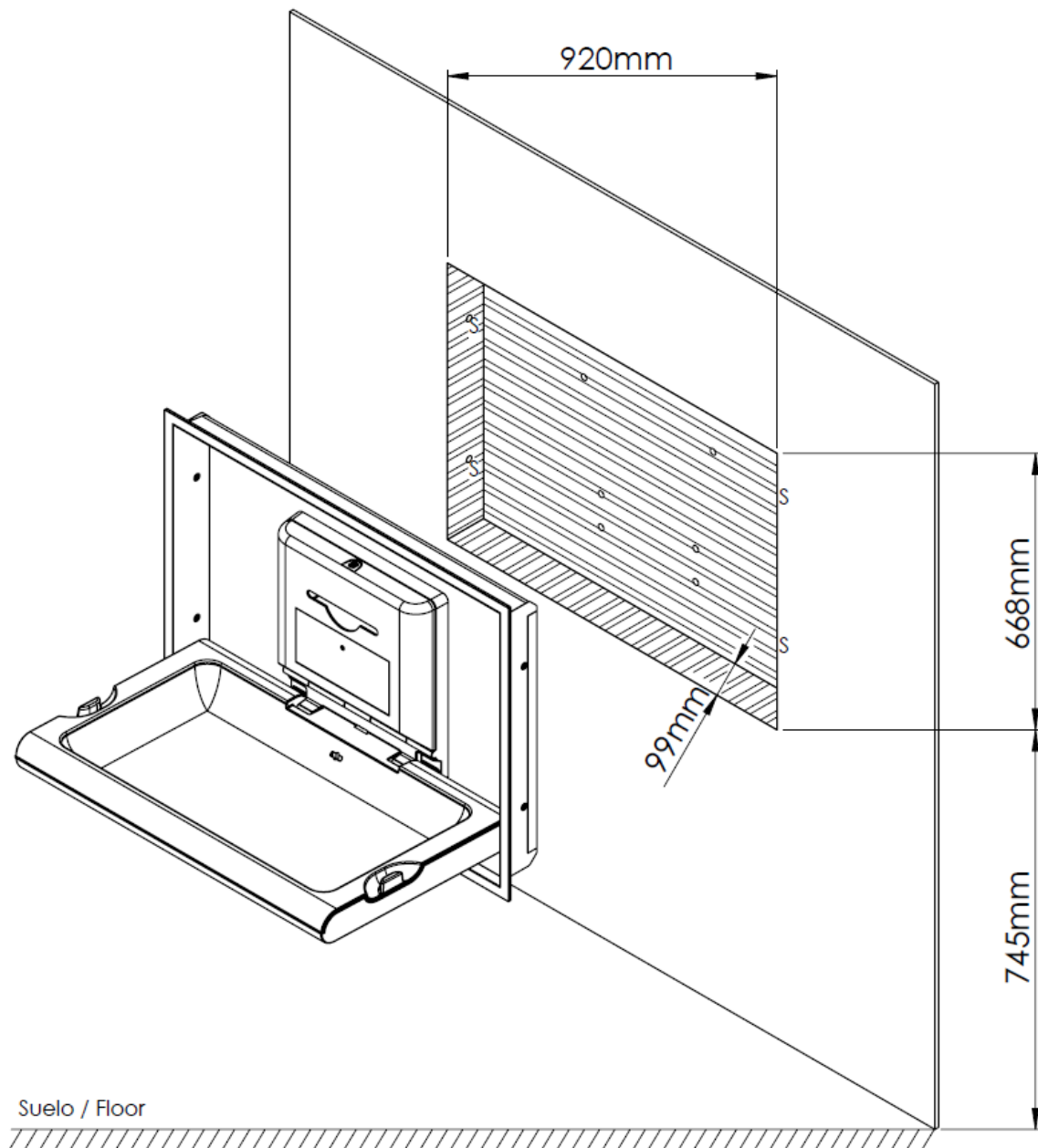

When installing the recessed kit, keep in mind that the bottom of the changing table must be at a height of approximately 800 mm from the ground.

Warning: Before installation please refer to the supplied installation manual as to ensure the unit will function properly and safely, it must be installed in accordance with these instructions.

Mediclinics, S.A., reserves the right to make changes and/or modifications to the products and their specifications without prior notice.

Review: 07-23

© mediclinics S.A.

